

TFMOV

Thermal Fuse & MOV (TFMOV)

TFMOV40K Series

Description

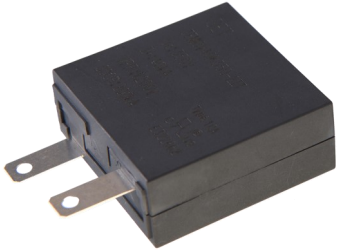

Thermal Fuse & MOV (TFMOV) is a thermally protected varistor that has all the characteristics of a thermally protected varistor (MOV). TFMOV has all the characteristics of a varistor (MOV) with thermal protection, and there are two types of deterioration: natural deterioration due to long-term operation and deterioration due to an abnormal surge. When a surge occurs, the leakage current of the degraded MOV continues to increase, causing the surface temperature of the MOV to continue to rise and the possibility of fire. At this time, the thermal cutoff (fusible alloy) in the TFMOV senses the abnormal temperature and operates (blows) to disconnect the MOV from the main circuit to protect the entire circuit, and the MOV itself will not continue to heat up and catch fire.

SETsafe | SETfuse Thermal Protection Varistors - Fusible Alloy TFMOV40K Series are mainly composed of Varistors (MOV), Thermal Cutoffs (Fusible Alloy) (ATCO), Flame Retardant Cases and Metal Components (Pins), Potting Materials. Vertical mounting structure; Nominal discharge current: (30 ~ 40) kA; Maximum continuous operating voltage: (50~ 750) VAC; Safety certificates: UL, cUL; RoHS, REACH compliant.

Schematics

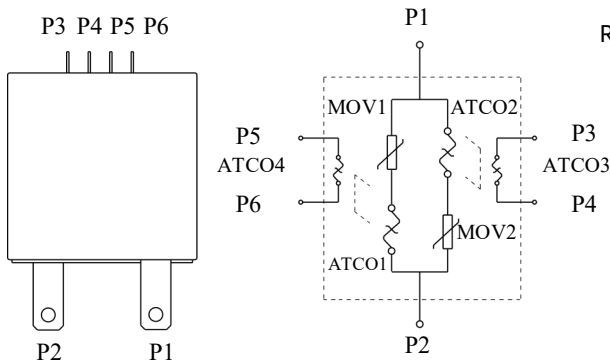

TFMOV(ATCO)

Structure

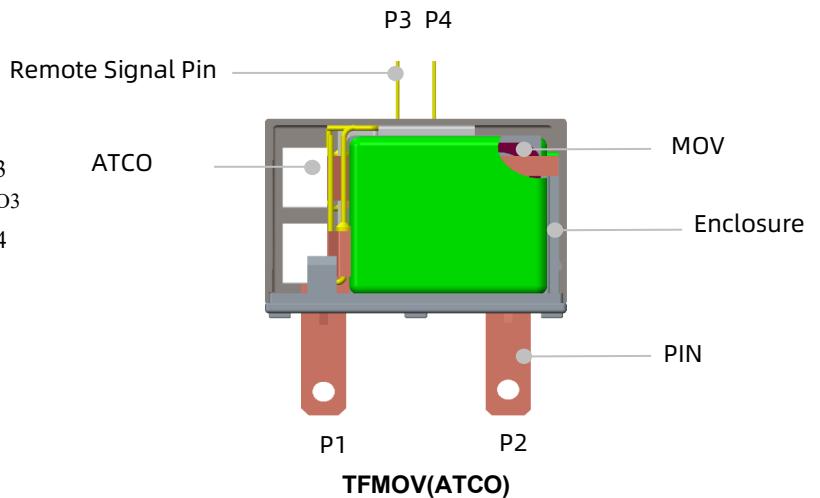

TFMOV(ATCO)

Features

- Thermal Protection, High Reliability
- Small Size
- Remote Signal Contact for Failure Indication (Optional)
- High Energy Capacity
- Epoxy Sealing Material, Flame-retardant to V0 (UL 94)
- Comply with UL 1449 / IEC 61643-11

Applications



- Telecom Equipment
- String Inverter in Photovoltaic System
- AC / DC Power Supply
- Uninterruptable Power Supply (UPS)
- Surge Protective Device (SPD)
- Electric Meter
- Power Distribution Unit (PDU)

TFMOV

Thermal Fuse & MOV (TFMOV)

TFMOV40K Series

Agency Approvals

Agency Symbol	Standards	The File No. and certification No. obtained by SETsafe SETfuse	Category
	UL 1449	E322662	Type 4CA
	CSA C22.2 NO. 269, CSA ECN 516	E322662	Type 4CA
Environment	RoHS & REACH	Compliant	

Part Numbering System

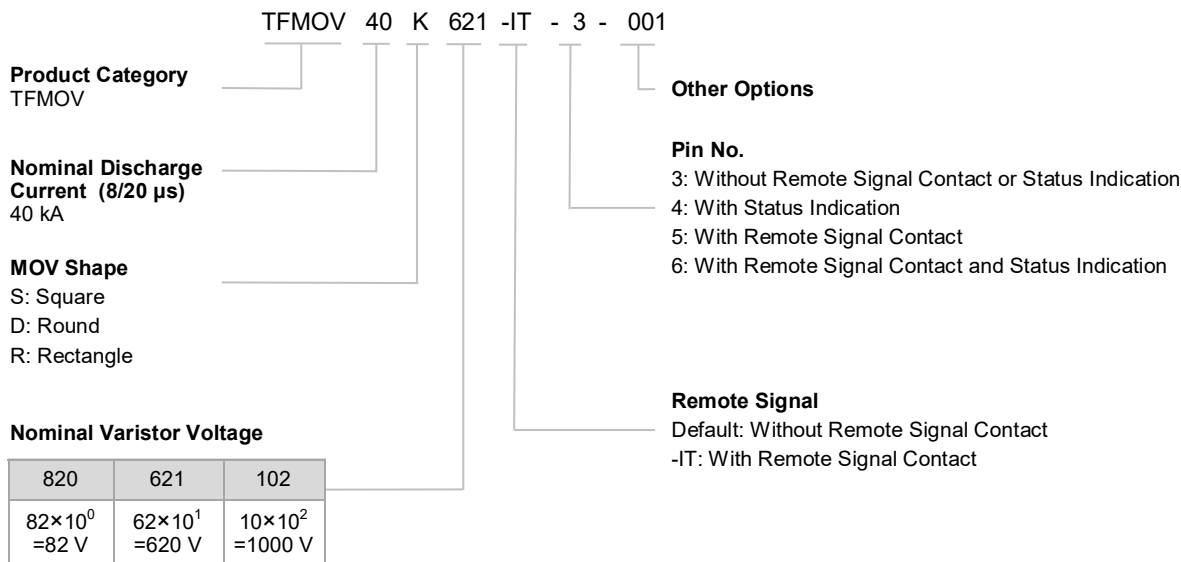

Reminder:

Part numbering system in the datasheet is only for selecting correct parameter and product features. Before placing order, please contact us for specifications and use the part number and product code in the specifications to place order to ensure the part is correct. Product code is the unique identification.

TFMOV

Thermal Fuse & MOV (TFMOV)

TFMOV40K Series

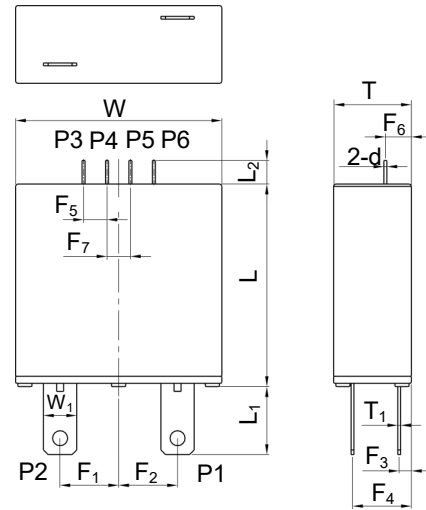
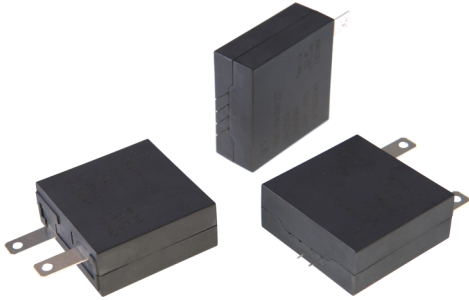

Note:
Pin P3 & P4 / P5 & P6 is optional.
Unit: mm

Nominal Varistor Voltage	L (±1.0)	L ₁ (±0.5)	L ₂ (±1.0)	W (±1.0)	W ₁ (±0.2)	T (±1.0)	T ₁ (±0.2)
40K820 ~ 201	42.7	14.5	5.0	44.0	7.1	12.6	0.6
40K221 ~ 471	42.7	14.5	5.0	44.0	7.1	14.6	0.6
40K511 ~ 621	42.7	14.5	5.0	44.0	7.1	16.5	0.6
40K681 ~ 821	42.7	14.5	5.0	44.0	7.1	18.5	0.6
40K911 ~ 122	42.7	14.5	5.0	44.0	7.1	23.0	0.6
Nominal Varistor Voltage	d (±0.05)	F ₁ (±0.3)	F ₂ (±0.3)	F ₃ (±0.5)	F ₄ (±0.5)	F ₅ (±0.5)	F ₆ (±0.5)
40K820 ~ 201	0.50	12.5	12.5	2.3	10.2	5.0	5.5
40K221 ~ 471	0.50	12.5	12.5	2.3	11.0	5.0	5.5
40K511 ~ 621	0.50	12.5	12.5	2.3	12.2	5.0	5.5
40K681 ~ 821	0.50	12.5	12.5	2.3	13.5	5.0	5.5
40K911 ~ 122	0.50	12.5	12.5	2.3	20.5	5.0	5.5
Model	L (±1.0)	L ₁ (±0.5)	L ₂ (±1.0)	W (±1.0)	W ₁ (±0.2)	T (±1.0)	T ₁ (±0.2)
TFMOV40K150x	42.7	14.5	5.0	44.0	7.1	14.6	0.6
TFMOV40K300x	42.7	14.5	5.0	44.0	7.1	14.6	0.6
TFMOV40K350x	42.7	14.5	5.0	44.0	7.1	16.5	0.6
TFMOV40K460x	42.7	14.5	5.0	44.0	7.1	18.5	0.6
TFMOV40K550x	42.7	14.5	5.0	44.0	7.1	18.5	0.6
Model	d (±0.05)	F ₁ (±0.3)	F ₂ (±0.3)	F ₃ (±0.5)	F ₄ (±0.5)	F ₅ (±0.5)	F ₆ (±0.5)
TFMOV40K150x	0.50	12.5	12.5	2.3	11.0	5.0	5.5
TFMOV40K300x	0.50	12.5	12.5	2.3	11.0	5.0	5.5
TFMOV40K350x	0.50	12.5	12.5	2.3	12.2	5.0	5.5
TFMOV40K460x	0.50	12.5	12.5	2.3	13.5	5.0	5.5
TFMOV40K550x	0.50	12.5	12.5	2.3	13.5	5.0	5.5

TFMOV

Thermal Fuse & MOV (TFMOV)

TFMOV40K Series

Specifications

Model	Max. Continuous Operating Voltage		Varistor Voltage @1 mA DC		Clamping Voltage (Max.)		Nominal Discharge Current (8/20 μs)	Max. Discharge Current (8/20 μs)	Voltage Clamping Ratio ^a		Max. Energy (Joule)	Typical Capacitance (Reference)	UL SPD Type
	U _c		Min.	Max.	V _c	I _p	I _n	I _{max}	R _{cl}	I _n	10/1000 μs	@1 kHz	
	(VAC)	(VDC)	(V)		(V)	(A)	(kA)			(kA)	(J)	(pF)	
TFMOV40K820x*	50	65	74	90	135	150	30	60	3.2	30	312	37900	Type 4CA
TFMOV40K101x*	60	85	90	110	165	150	30	60	3.2	30	390	30000	Type 4CA
TFMOV40K121x*	75	100	108	132	200	150	30	60	3.2	30	470	24400	Type 4CA
TFMOV40K151x*	95	125	135	165	250	150	30	60	3.2	30	592	20000	Type 4CA
TFMOV40K181x*	115	150	162	198	300	150	30	60	2.3	30	700	16500	Type 4CA
TFMOV40K201x*	130	170	185	225	340	150	40	100	2.3	40	800	13500	Type 4CA
TFMOV40K221x*	140	180	198	242	360	150	40	100	2.3	40	900	12800	Type 4CA
TFMOV40K241x*	150	200	216	264	395	150	40	100	2.3	40	960	11300	Type 4CA
TFMOV40K271x*	175	225	243	297	455	150	40	100	2.3	40	1080	10200	Type 4CA
TFMOV40K301x*	190	250	270	330	500	150	40	100	2.3	40	1200	9020	Type 4CA
TFMOV40K331x*	210	275	297	363	550	150	40	100	2.3	40	1312	8300	Type 4CA
TFMOV40K361x*	230	300	324	396	595	150	40	100	2.3	40	1490	7500	Type 4CA
TFMOV40K391x*	250	320	351	429	650	150	40	100	2.3	40	1660	7000	Type 4CA
TFMOV40K431x*	275	350	387	473	710	150	40	100	2.3	40	1840	5900	Type 4CA
TFMOV40K471x*	300	385	423	517	775	150	40	100	2.3	40	2000	5760	Type 4CA
TFMOV40K511x*	320	415	459	561	845	150	40	100	2.3	40	2120	5300	Type 4CA
TFMOV40K561x*	350	460	504	616	925	150	40	100	2.3	40	2300	4900	Type 4CA
TFMOV40K621x*	385	505	558	682	1025	150	40	100	2.3	40	2500	4400	Type 4CA
TFMOV40K681x*	420	560	612	748	1120	150	40	80	2.3	40	2500	4000	Type 4CA
TFMOV40K751x*	460	615	675	825	1240	150	40	80	2.3	40	2560	3640	Type 4CA
TFMOV40K821x*	510	670	738	902	1355	150	40	80	2.3	40	2600	3600	Type 4CA
TFMOV40K911x*	550	745	819	1001	1500	150	40	80	2.3	40	2950	3000	Type 4CA
TFMOV40K102x*	625	825	900	1100	1650	150	40	80	2.3	40	3100	2700	Type 4CA
TFMOV40K112x*	680	895	990	1210	1815	150	40	80	2.3	40	3500	2460	Type 4CA
TFMOV40K122x*	750	1000	1080	1320	1980	150	40	80	2.3	40	4000	2270	Type 4CA

Notes:

a: $R_{cl} = \frac{V_c}{V_N}$, $U_p \geq V_c$, V_c : Clamping Voltage (@ I_n), V_N : Varistor Voltage, U_p : Voltage Protection Level.

The Value of Voltage Protection Level (U_p) is determined according to IEC 61643-11:2011 clause 6.4.

Preferred values of voltage protection level (kV): 0.08, 0.09, 0.10, 0.12, 0.15, 0.22, 0.33, 0.4, 0.5, 0.6, 0.7, 0.8, 0.9, 1.0, 1.2, 1.5, 1.8, 2.0, 2.5, 3.0, 4.0, 5.0, 6.0, 8.0, 10.

*: Optional Remote Signal Function, -IT with One Remote Signal P3 & P4, -2IT with Two Remote Signal P3 & P4 and P5 & P6.

TFMOV

Thermal Fuse & MOV (TFMOV)

TFMOV20K Series

Model	Nominal System Voltage	Max. Continuous Operating Voltage	Nominal Discharge Current (8/20 μ s)	Max. Discharge Current (8/20 μ s)	Voltage Protection Rating	SCCR	UL SPD Type
	U_n	U_c	I_n	I_{max}	VPR (@6kV/3kA)		
	(VAC)	(VAC)	(kA)		(V)	(kA)	UL 1449
TFMOV40K150x	120	150	40	100	600	200	Type 1CA
TFMOV40K300x	220	300	40	100	900	200	Type 1CA
TFMOV40K350x	277	350	40	100	1200	200	Type 1CA
TFMOV40K460x	347	460	40	80	1500	150	Type 1CA
TFMOV40K550x	480	550	40	80	1500	150	Type 1CA

Performance Curve for Reference

Limited Current Test Curve (UL 1449 clause 44.4)

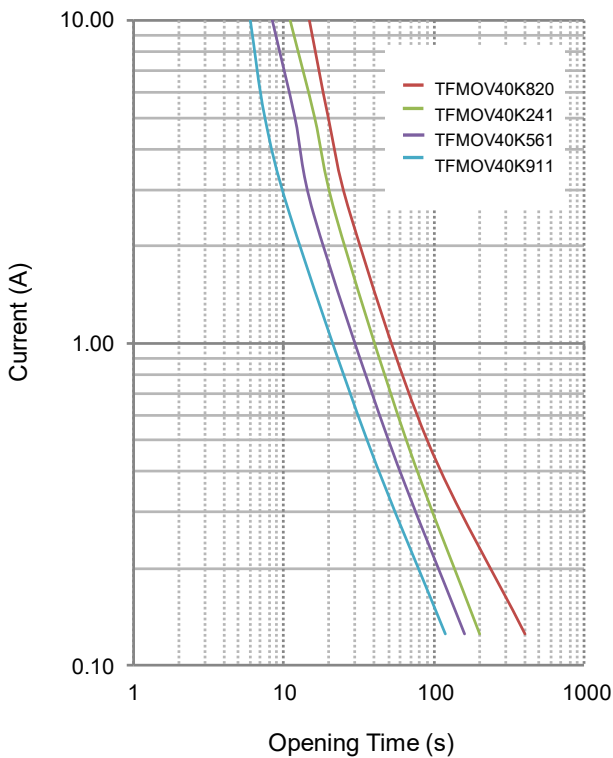

Note:
The limited current test curve is for reference only.

Max. Peak Current Derating Curve

TFMOV40K201x to TFMOV40K122x

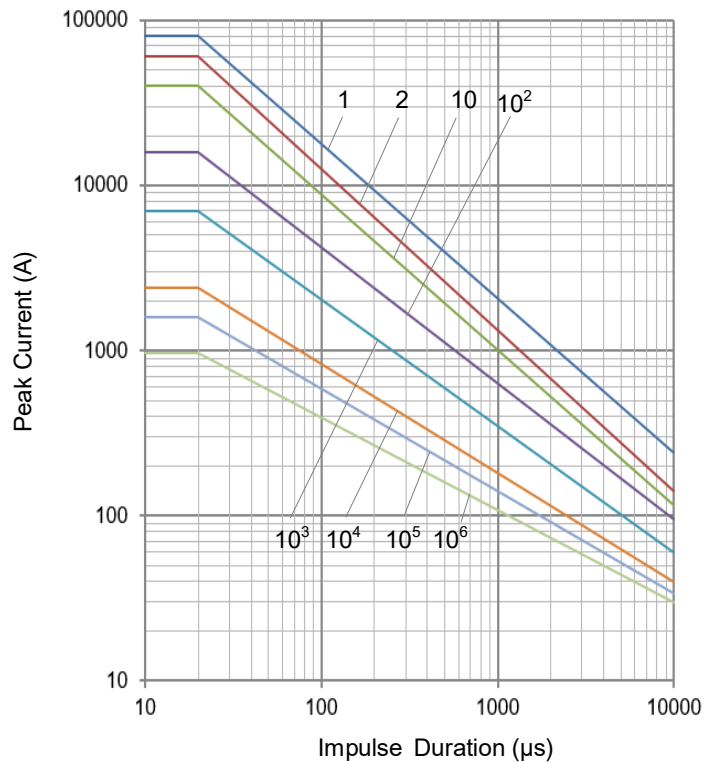

Note:
1, 2, 10, 10², 10³, 10⁴, 10⁵, 10⁶ Stand for number of repetitions.

TFMOV

Thermal Fuse & MOV (TFMOV)

TFMOV40K Series

Voltage-Current Characteristic Curves

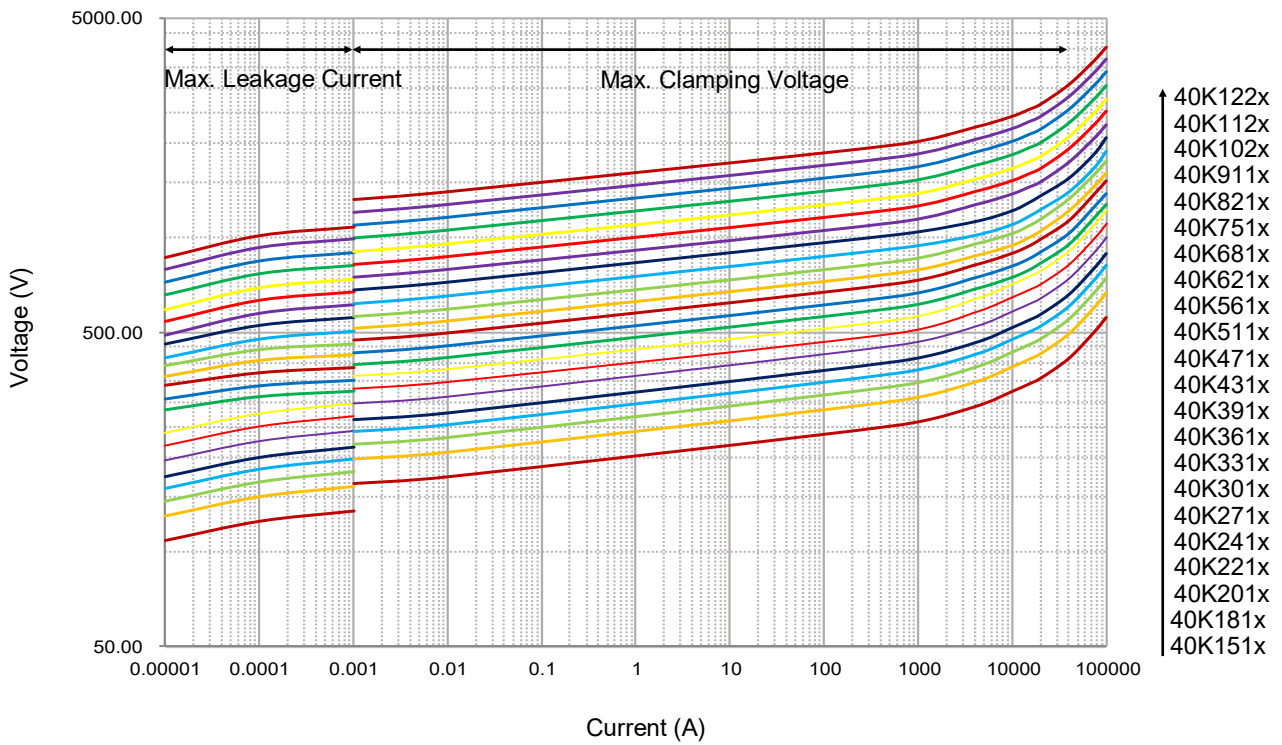
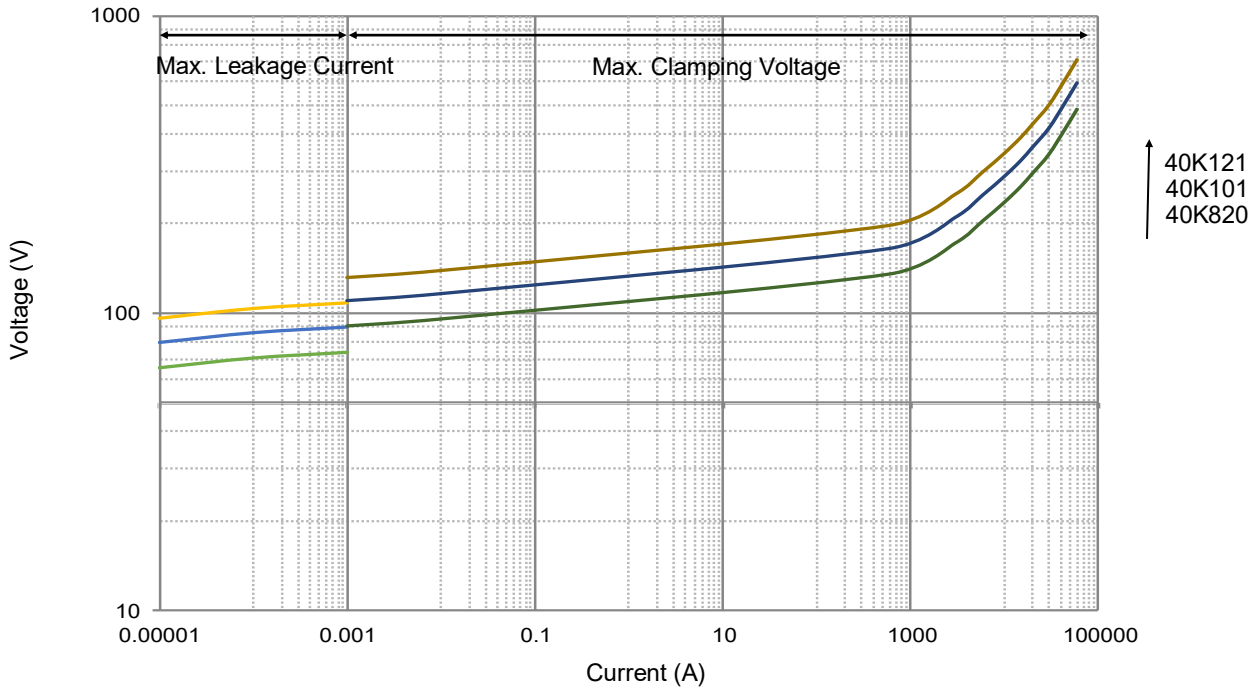

TFMOV

Thermal Fuse & MOV (TFMOV)

TFMOV20K Series

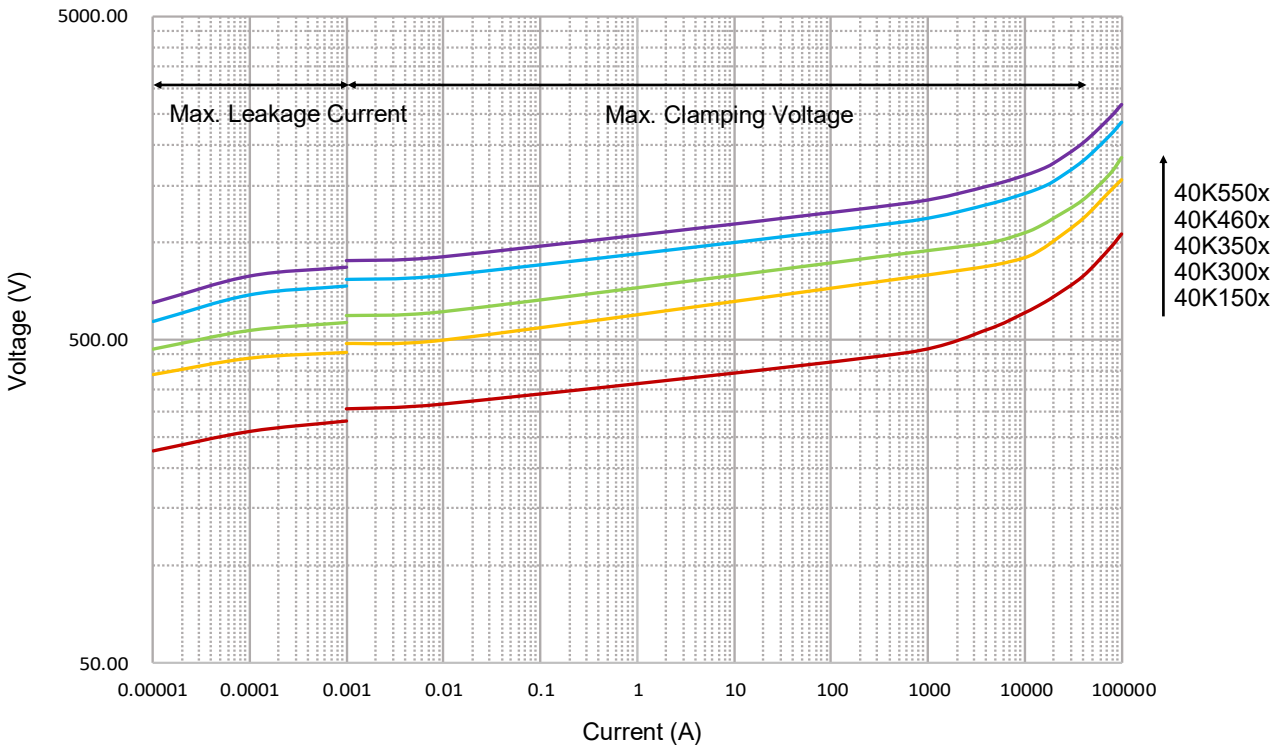

Packaging Information

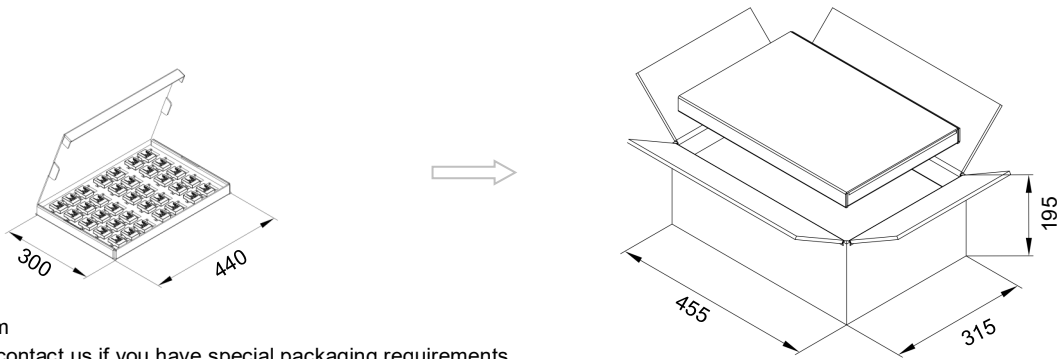

Unit: mm
Please contact us if you have special packaging requirements.

Item	Nominal Varistor Voltage	Box	Carton
Dimensions (mm)	N/A	440 × 300	455 × 315 × 195
Quantity (PCS)	820 ~ 201	50	200
	221 ~ 821	50	150
	911 ~ 122	25	100

TFMOV

Thermal Fuse & MOV (TFMOV)

TFMOV40K Series

Wave Soldering Parameters (Reference)

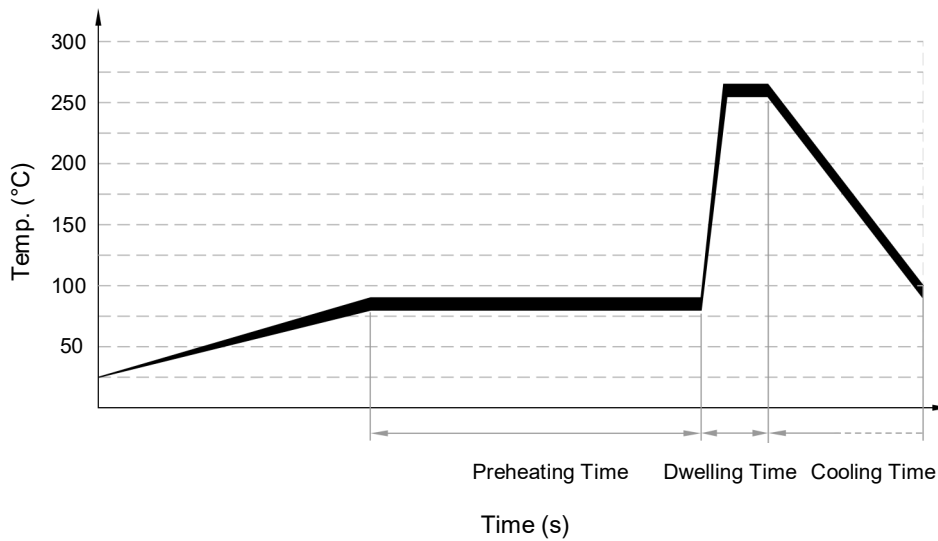

Item	Temp. (°C)	Time (s)
Preheating	80 to 90	60 to 150
Dwelling	250 to 260	2 to 4

Recommended Hand-Soldering Parameters

Item	Condition
Iron Temperature	350 °C (Max.)
Soldering Time	4 seconds (Max.)
Distance between Soldering Point and the Bottom of Product	2 mm (Min.)

TFMOV

Thermal Fuse & MOV (TFMOV)

TFMOV40K Series

Application Options

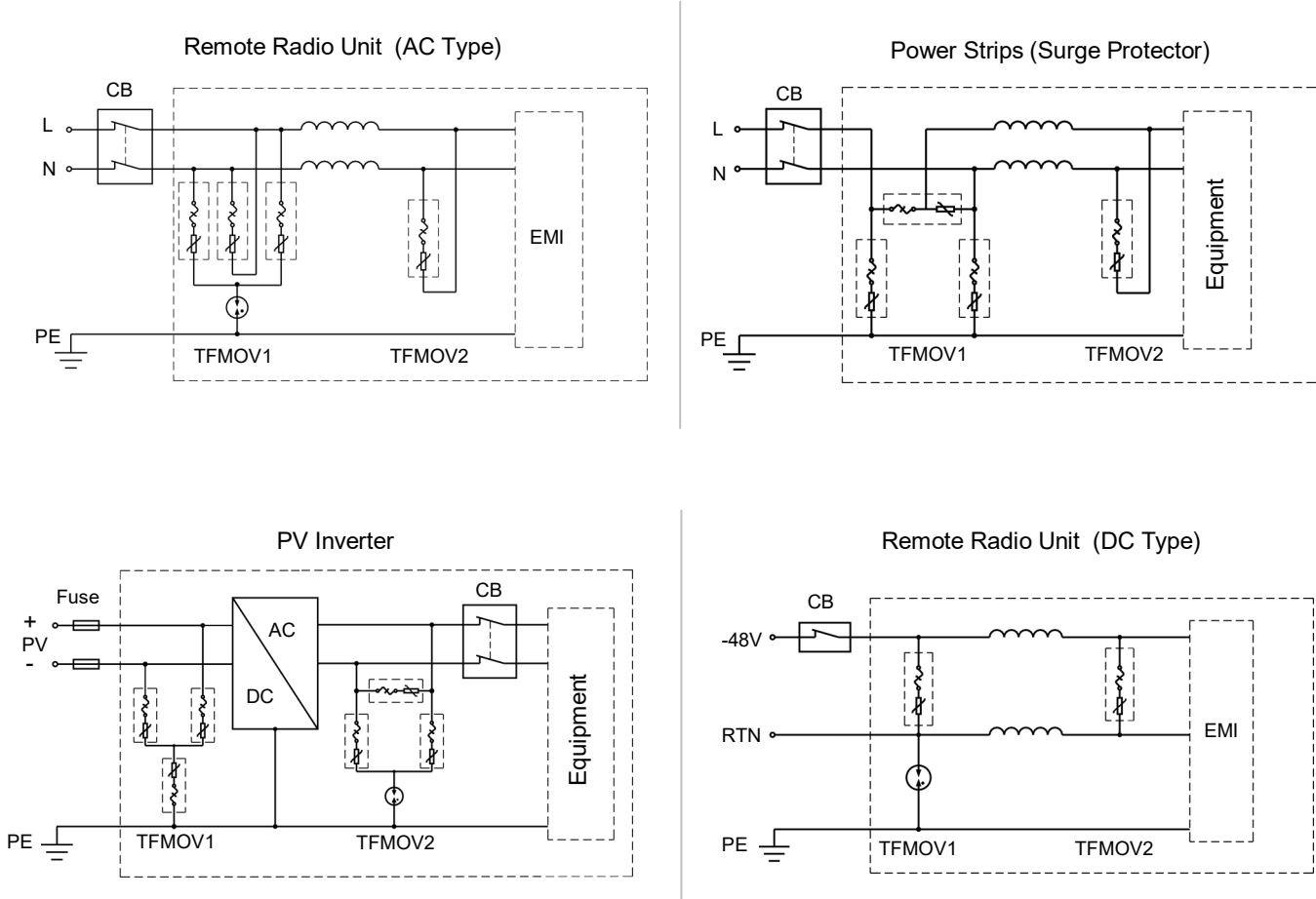

Design

When a single TFMOV surge capacity can't meet the requirement of customers, paralleling more TFMOVs is recommended. Due to its nonlinear current-voltage characteristics, please pay attention to below tips:

1. Use the TFMOV from the same manufacturer with same model to parallel.
2. Control the varistor voltage; Typically, the varistor voltage deviation should be less than 1% in the same group (between the Max and Min), and meet the next tip at the same time.
3. Calculate the average surge capacity for each TFMOV and keep a margin at least 10%.
4. Design the layout like Figure.2. to make sure the surge capacity is divided averagely.

The Design not Recommended

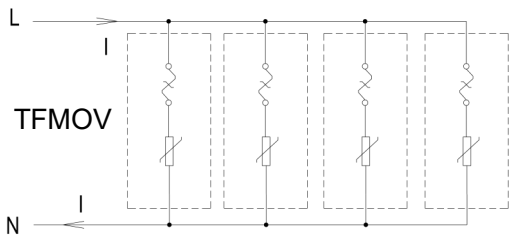

Figure .1

The Design Recommended

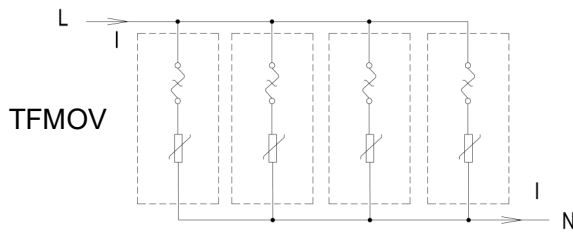

Figure .2

TFMOV

Thermal Fuse & MOV (TFMOV)

TFMOV40K Series

MOV Operation Principle

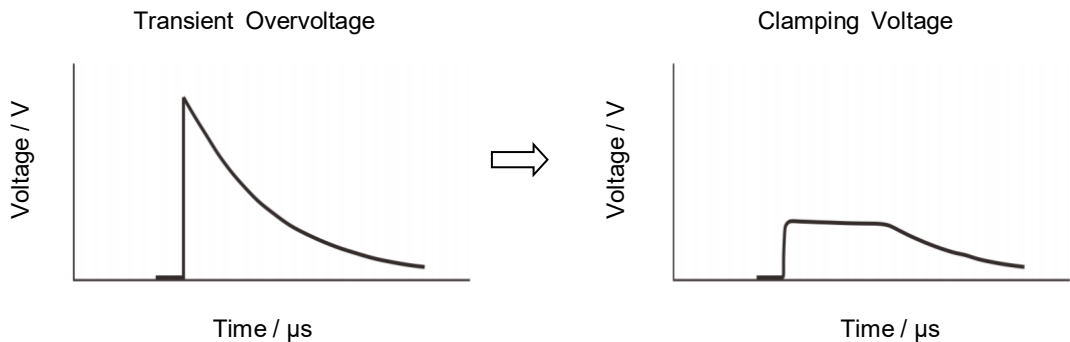

MOV Thermal Protection

Figure a is a surge protection circuit commonly used in power supplies. MOV is used to suppress the surge voltage and protect the subsequent circuit. There is a risk of burning when the varistor degrades or fails. In the high-reliability surge protection circuit of Figure b, in order to improve the safety of the circuit, a thermal protection varistor TFMOV is used as the surge voltage protection element. TFMOV is a combination of varistors (MOV) and thermal protection component. When the temperature of the MOV is abnormally exceeded, the thermal fuse will be opened first, so that the failure mode of the MOV appears to be open-circuit failure.

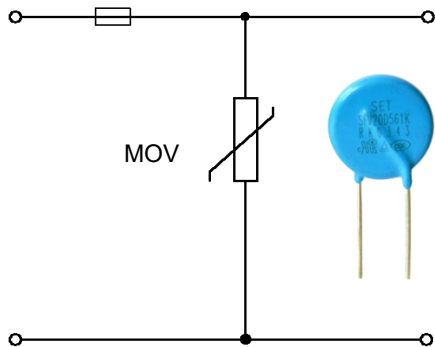

Figure a Typical surge protection circuit

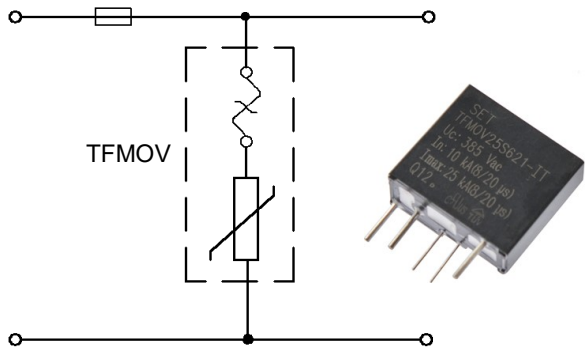

Figure b: High reliability surge protection circuit

TFMOV

Thermal Fuse & MOV (TFMOV)

TFMOV40K Series

Benefits

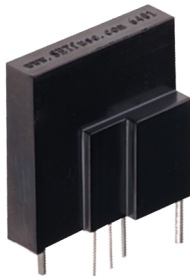

Safety

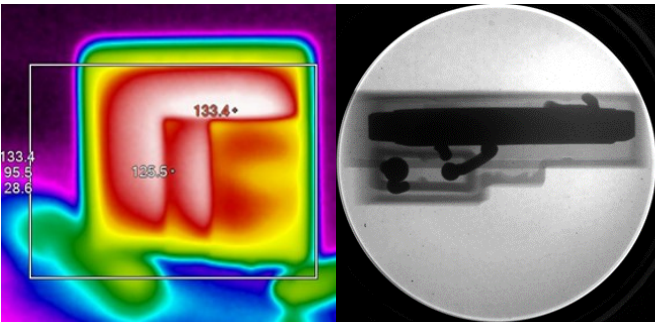

TFMOV Failure Simulation

During the electrical performance degrading of varistor, the inbuilt ATCO will open the circuit when the leakage current of varistor increases to tens of micro Amperes. As shown in the figure above, this is a safe open circuit failure.



Hidden Danger

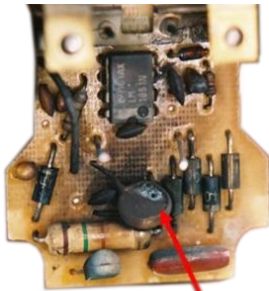

Hole in Varistor



MOV Failure Simulation

The electrical performance of varistor degrades with operating, mostly the varistor voltage drops, and leakage current increases. The heat accumulation can cause the temperature increase sharply and varistor results in thermal breakdown to short circuit status. It's very dangerous.

Glossary

Item	Description
V_N	Nominal Varistor Voltage Voltage, at specified d.c. current used as a reference point in the component characteristic.
8/20 μ s	8/20 Current Impulse Current impulse with a nominal virtual front time of 8 μ s and a nominal time to half-value of 20 μ s. — (IEC 61643-11)
1.2/50 μ s	1.2/50 Voltage Impulse Voltage impulse with a nominal virtual front time of 1.2 μ s and a nominal time to half-value of 50 μ s. — (IEC 61643-11)
U_c	Maximum Continuous Operating Voltage Maximum r.m.s. voltage, which may be continuously applied to the SPD's mode of protection. — (IEC 61643-11)
I_n	Nominal Discharge Current Crest value of the current through the SPD having a current waveshape of 8/20 μ s. — (IEC 61643-11)
I_{imp}	Impulse Discharge Current for Class I Test Crest value of a discharge current through the SPD with specified charge transfer Q and specified energy W/R in the specified time. — (IEC 61643-11)
I_{max}	Maximum Discharge Current Crest value of a current through the SPD having an 8/20 μ s waveshape and magnitude according to the manufacturers specification. I_{max} is equal to or greater than I_n . — (IEC 61643-11)
V_c	Clamping Voltage Peak voltage developed across the varistor terminations under standard atmospheric conditions, when passing an 8/20 μ s class current pulse.
C_v	Capacitance Capacitance across the MOV measured at a specified frequency and voltage.
Modes of protection	Modes of protection An intended current path, between terminals that contains protective components, e.g. line-to-line, line-to-earth, line-to-neutral, neutral-to-earth. — (IEC 61643-11)
U_p	Voltage Protection Level Maximum voltage to be expected at the SPD terminals due to an impulse stress with defined voltage steepness and an impulse stress with a discharge current with given amplitude and wave shape. — (IEC 61643-11)
TCO	Thermal-Link A non-resettable device incorporating a THERMAL ELEMENT which will open a circuit once only when exposed for a sufficient length of time to a temperature in excess of that for which it has been designed.
ATCO	Alloy Thermal-Link Alloy Type Thermal-Link, Alloy is the thermal element.
MOV	Varistors A resistive device with nonlinear voltammetry characteristics

TFMOV

Thermal Fuse & MOV (TFMOV)

TFMOV40K Series

Patents

Name	Region	Category	Patent NO.
Varistor with In-built Alloy-Type Thermal Fuse	China	Patent for Invention	ZL 200510044661.5
A Protection Pluggable Module with Over Current、Over Voltage、and Over Temperature Protection Function	China	Utility Model	ZL 201020244488.X
A Varistor with Double Protection Function	China	Utility Model	ZL 201020255481.8
Surge Protection Module Applicable for Power Strip	China	Utility Model	ZL 201120107173.5
A Surge Protection Module Applicable for Power Strip	China	Patent for Invention	ZL 201110092261.7
A New Type of Varistor and Surge Protective Device with Thermal Protection	China	Utility Mode	ZL 201420306127.1
A Surge Protective Device	China	Utility Modeel	ZL 201420415059.2
A Varistor and Thermal Protection Component Combination	China	Utility Mode	ZL 201520376567.9
合金型温度ヒューズ付のバリスタ	Japan	Utility Mode	3142835
Varistor with an Alloy-Type Temperature Fuse	Australia	Utility Mode	2007100456
Varistor with an Alloy-Type Temperature Fuse	Taiwan	Utility Model	M 300855
Varistor with an Alloy-type Temperature Fuse	Canada	Patent for Invention	2588819
Metal Oxide Varistor with Built-in Alloy-Type Temperature Fuse	USA	Patent for Invention	US 8780521
Varistor with In-built Alloy Type Thermal Fuse (with Housing)	USA	Patent for Invention	US 9355763



ATTENTION

Usage

1. Frequency range is from 47 Hz to 63 Hz.
2. The voltage applied continuously to the TFMOV can not exceed its maximum continuous operating voltage U_c .
3. When atmosphere press is from 80 kPa to 106 kPa, the related altitude shall be from 2000 meters to - 500 meters.
4. Do not touch the product body or pins directly when power is on, to avoid electric shock.
5. Do not clean the TFMOV with strong polar solvent such as ketone, esters, benzene, halogenated hydrocarbon, to avoid damaging the enclosure.
6. It should have a reliable grounding when using these products.

Replacement

TFMOV is a non-repairable product. For safety sake, please use equivalent TFMOV for replacement.

Storage

Do not store TFMOV at high temperature, high humidity or corrosive gas environment. To avoid reducing the solderability of the pins, please use them up within 1 year after receiving the goods.

Installation Position

Do not install the TFMOV on a place that may often suffer severe continuous vibration.

Mechanical Stress

Do not take violent action such as knocking when assembling to avoid mechanical damage.

Thermal Fuse & MOV (TFMOV) Feature & Model List Overview

Rated Voltage U_n (V)	AC	DC	Nominal Discharge Current I_n (kA)										Maximum Continuous Operating Voltage U_n (V)		Model	
			1	1.5	2.5	3	4	5	AC	DC						
690V	600V		○	○	○	○	○	○	○	○	○	○	○	750	1000	
			○	○	○	○	○	○	○	○	○	○	○	680	895	
480V	400V		○	○	○	○	○	○	○	○	○	○	○	625	825	
			○	○	○	○	○	○	○	○	○	○	○	550	745	
347V	254		○	○	○	○	○	○	○	○	○	○	○	510	670	
			○	○	○	○	○	○	○	○	○	○	○	460	615	
220	277V		○	○	○	○	○	○	○	○	○	○	○	420	560	
			○	○	○	○	○	○	○	○	○	○	○	385	505	
230V	300V		○	○	○	○	○	○	○	○	○	○	○	350	460	
			○	○	○	○	○	○	○	○	○	○	○	320	415	
120	220V		○	○	○	○	○	○	○	○	○	○	○	300	385	
			○	○	○	○	○	○	○	○	○	○	○	275	350	
130V	110V		○	○	○	○	○	○	○	○	○	○	○	250	320	
			○	○	○	○	○	○	○	○	○	○	○	230	300	
110V	110V		○	○	○	○	○	○	○	○	○	○	○	210	275	
			○	○	○	○	○	○	○	○	○	○	○	190	250	
60V	60V		○	○	○	○	○	○	○	○	○	○	○	175	225	
			○	○	○	○	○	○	○	○	○	○	○	150	200	
48V	48V		○	○	○	○	○	○	○	○	○	○	○	140	180	
			○	○	○	○	○	○	○	○	○	○	○	130	170	
36V	36V		○	○	○	○	○	○	○	○	○	○	○	115	150	
			○	○	○	○	○	○	○	○	○	○	○	95	125	
24V	24V		○	○	○	○	○	○	○	○	○	○	○	75	100	
			○	○	○	○	○	○	○	○	○	○	○	60	85	
12V	12V		○	○	○	○	○	○	○	○	○	○	○	50	65	
			○	○	○	○	○	○	○	○	○	○	○	40	56	
			○	○	○	○	○	○	○	○	○	○	○	35	45	
			○	○	○	○	○	○	○	○	○	○	○	30	38	
			○	○	○	○	○	○	○	○	○	○	○	25	31	
			○	○	○	○	○	○	○	○	○	○	○	20	26	
			○	○	○	○	○	○	○	○	○	○	○	17	22	

Thermal Fuse & MOV (TFMOV) Feature & Model List Overview

Rated Voltage U_n (V)	AC	DC	Model								Maximum Continuous Operating Voltage U_n (V)		
			7.5	8	10	10	10	15	15	AC	DC		
690V	600V		TFMOV20S122x	○	○	○	TFMOV25D122x	TFMOV25S122x	○	○	○	750	1000
			TFMOV20S112x	○	○	○	TFMOV25D112x	TFMOV25S112x	○	○	○	680	895
480V	400V		TFMOV20S102x	○	○	○	TFMOV25D102x	TFMOV25S102x	○	○	○	625	825
			TFMOV20S911x	○	○	○	TFMOV25D911x	TFMOV25S911x	○	○	○	550	745
347V	300V		TFMOV20S821x	○	○	○	TFMOV25D821x	TFMOV25S821x	○	○	○	510	670
			TFMOV20S751x	○	○	○	TFMOV25D751x	TFMOV25S751x	○	○	○	460	615
220 - 230V	254 - 277V		TFMOV20S681x	TFMOV20S681Lx	○	○	TFMOV25D681x	TFMOV25S681x	TFMOV25S681Lx	○	○	420	560
			TFMOV20S621x	TFMOV20S621Lx	○	○	TFMOV25D621x	TFMOV25S621x	TFMOV25S621Lx	○	○	385	505
220 - 230V	300V		TFMOV20S561x	TFMOV20S561Lx	○	○	TFMOV25D561x	TFMOV25S561x	TFMOV25S561Lx	○	○	350	460
			TFMOV20S511x	TFMOV20S511Lx	○	○	TFMOV25D511x	TFMOV25S511x	TFMOV25S511Lx	○	○	320	415
120 - 130V	220V		TFMOV20S471x	TFMOV20S471Lx	○	○	TFMOV25D471x	TFMOV25S471x	TFMOV25S471Lx	○	○	300	385
			TFMOV20S431x	TFMOV20S431Lx	○	○	TFMOV25D431x	TFMOV25S431x	TFMOV25S431Lx	○	○	275	350
110V	110V		TFMOV20S391x	TFMOV20S391Lx	○	○	TFMOV25D391x	TFMOV25S391x	TFMOV25S391Lx	○	○	250	320
			TFMOV20S361x	TFMOV20S361Lx	○	○	TFMOV25D361x	TFMOV25S361x	TFMOV25S361Lx	○	○	230	300
110V	110V		TFMOV20S331x	TFMOV20S331Lx	○	○	TFMOV25D331x	TFMOV25S331x	TFMOV25S331Lx	○	○	210	275
			TFMOV20S301x	TFMOV20S301Lx	○	○	TFMOV25D301x	TFMOV25S301x	TFMOV25S301Lx	○	○	190	250
48V	60V		TFMOV20S271x	TFMOV20S271Lx	○	○	TFMOV25D271x	TFMOV25S271x	TFMOV25S271Lx	○	○	175	225
			TFMOV20S241x	TFMOV20S241Lx	○	○	TFMOV25D241x	TFMOV25S241x	TFMOV25S241Lx	○	○	150	200
48V	48V		TFMOV20S221x	TFMOV20S221Lx	○	○	TFMOV25D221x	TFMOV25S221x	TFMOV25S221Lx	○	○	140	180
			TFMOV20S201x	TFMOV20S201Lx	○	○	TFMOV25D201x	TFMOV25S201x	TFMOV25S201Lx	○	○	130	170
24V	24V		○	○	TFMOV25S181x	TFMOV25S181Lx	○	○	○	○	TFMOV20K181x	115	150
			○	○	TFMOV25S151x	TFMOV25S151Lx	○	○	○	○	TFMOV20K151x	95	125
24V	24V		○	○	TFMOV25S121x	TFMOV25S121Lx	○	○	○	○	TFMOV34S121x	75	100
			○	○	TFMOV25S101x	TFMOV25S101Lx	○	○	○	TFMOV34S680Lx	TFMOV34S101x	60	85
12V	12V		○	○	TFMOV25S820x	TFMOV25S820Lx	○	○	○	TFMOV34S560Lx	TFMOV34S820x	50	65
			○	○	○	○	TFMOV34S680x	○	○	TFMOV34S470Lx	○	40	56
12V	12V		○	○	○	○	TFMOV34S560x	○	○	○	○	35	45
			○	○	○	○	TFMOV34S470x	○	○	○	○	30	38
			○	○	○	○	○	○	○	○	25	31	
			○	○	○	○	○	○	○	○	20	26	
			○	○	○	○	○	○	○	○	17	22	

Thermal Fuse & MOV (TFMOV) Feature & Model List Overview

Rated Voltage U_n (V)	Model	Maximum Continuous Operating Voltage U_n (V)	
		AC	DC
690V	600V	750	1000
		680	895
480V	400V	625	825
		550	745
347V	300V	510	670
		460	615
220 - 230V	254 - 277V	420	560
		385	505
110V	120 - 130V	350	460
		320	415
60V	60V	300	385
		275	350
48V	48V	250	320
		230	300
24V	24V	210	275
		190	250
12V	12V	175	225
		150	200
48V	48V	140	180
		130	170
24V	24V	115	150
		95	125
12V	12V	75	100
		60	85
12V	12V	50	65
		40	56
12V	12V	35	45
		30	38
12V	12V	25	31
		20	26
12V	12V	17	22

Nominal Discharge Current I_n (kA)

$I_{max} = 2.5I_n$

Thermal Fuse & MOV (TFMOV) Feature & Model List Overview

Rated Voltage U_n (V)	AC	DC	Nominal Discharge Current I_n (kA)						Maximum Continuous Operating Voltage U_n (V)	
			2.5 x 2	5 x 2	7.5 x 2	2.5 x 3	5 x 3	7.5 x 3	AC	DC
690V									750	1000
600V									680	895
480V									625	825
400V									550	745
347V									510	670
254									460	615
220									420	560
230V									385	505
300V					TFMOV21R2P511				350	460
					TFMOV21R2P471			TFMOV21R3P511	320	415
					TFMOV21R2P431			TFMOV21R3P471	300	385
					TFMOV21R2P391			TFMOV21R3P431	275	350
120					TFMOV21R2P361			TFMOV21R3P391	250	320
130V					TFMOV21R2P331			TFMOV21R3P361	230	300
					TFMOV21R2P301			TFMOV21R3P331	210	275
					TFMOV21R2P271			TFMOV21R3P301	190	250
					TFMOV21R2P241			TFMOV21R3P271	175	225
110V					TFMOV21R2P221			TFMOV21R3P241	150	200
					TFMOV21R2P201			TFMOV21R3P221	140	180
								TFMOV21R3P201	130	170
					TFMOV21R2P181			TFMOV21R3P181	115	150
60V					TFMOV21R2P151			TFMOV21R3P151	95	125
48V					TFMOV21R2P121			TFMOV21R3P121	75	100
					TFMOV21R2P101			TFMOV21R3P101	60	85
36V					TFMOV21R2P820			TFMOV21R3P820	50	65
									40	56
24V					TFMOV21R2P680			TFMOV21R3P680	35	45
					TFMOV21R2P560			TFMOV21R3P560	30	38
					TFMOV21R2P470			TFMOV21R3P470	25	31
12V									20	26
									17	22